

Varenummer: 432000018
Beskrivelse: Rota-fix spændelement A 18x47
Rustfast stål

Mål

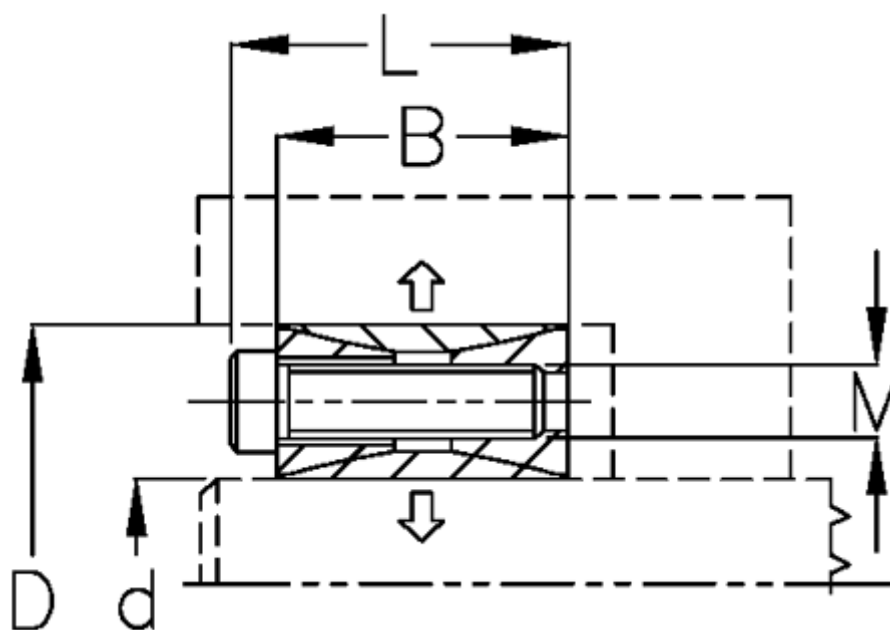

B mm	= 20
d H8 mm	= 18
D mm	= 47
F kN aksialkraft	= 17.0
L mm	= 26
M mm	= M6
Overfladeruhed	= R? ? 3.2 μ m
P N/mm ² fladetryk på aksel/nav	= 31

T Nm drejningsmoment	= 150
Tolerance	= Aksel k11-h11, Nav M6
Ts Nm boltetilspændingsmoment	= 8.8